

## Regenerative AC/DC Grid Emulator

The GE+ vAC/DC Full is the most complete and flexible Voltage Source, for AC and DC Test Platforms. Based on a Regenerative and Bidirectional power hardware, it is an essential laboratory device for testing and R&D applications in Renewable Energy Sources (PV, WT, CHP), grid connected devices, Smartgrids, Batteries, Electrical Vehicles and EV Chargers and Power HiL.

### Key features

Bidirectional and Regenerative  
Clean grid current: THDi < 3% and PF > 0.98  
Same power in DC and AC

13 models from 7.5kW to 160kW  
Parallelization of units to increase the power

Generation of Worldwide electrical grids:  
3-phase/ 1-phase/ split phase/ Multichannel

Independent phase configuration of:  
voltage rms, phase angle, frequency and harmonics

Generation of disturbances:  
harmonics, interharmonics, subharmonics, voltage dips  
frequency variation, flicker

Disturbance Generation Editor compatible with IEC,  
LVRT, SEMI-F47, CBEMA test standards

Intuitive User Interface  
Modbus/Ethernet Open protocol, Labview drivers



### Highlights



Efficiency and Flexibility

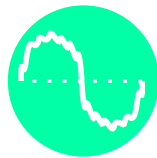

Harmonics Generation



Full options and power in AC&DC

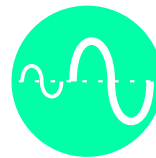

Power Amplifier



High-Resolution and Dynamics

### Applications

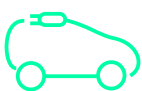

Electrical Vehicles and EVSE

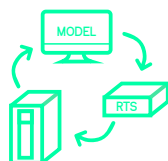

Power HiL



PV Inverter Emulation and PV Inverter Testing



Battery Testing and Emulation

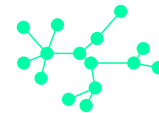

Smartgrids and ESS



IEC Testing

# Bidirectional and Regenerative Hardware

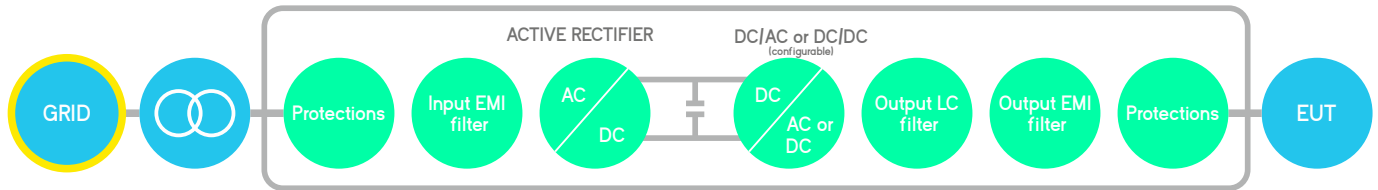

The hardware platform is based on a Back-to-Back power conversion topology, formed by two IGBT-based power stages. The grid side stage is an Active Rectifier which produces clean sinusoidal currents with very low harmonic distortion and power factor close to one.

The EUT side stage can be configured for AC voltage source or AC current source or DC output. In AC, voltage/current are controlled by using state of the art digital Proportional-Resonant controllers. In DC, the three independent buck-boost bidirectional legs enable the separated control of three different DC voltages or currents.

## Block diagram

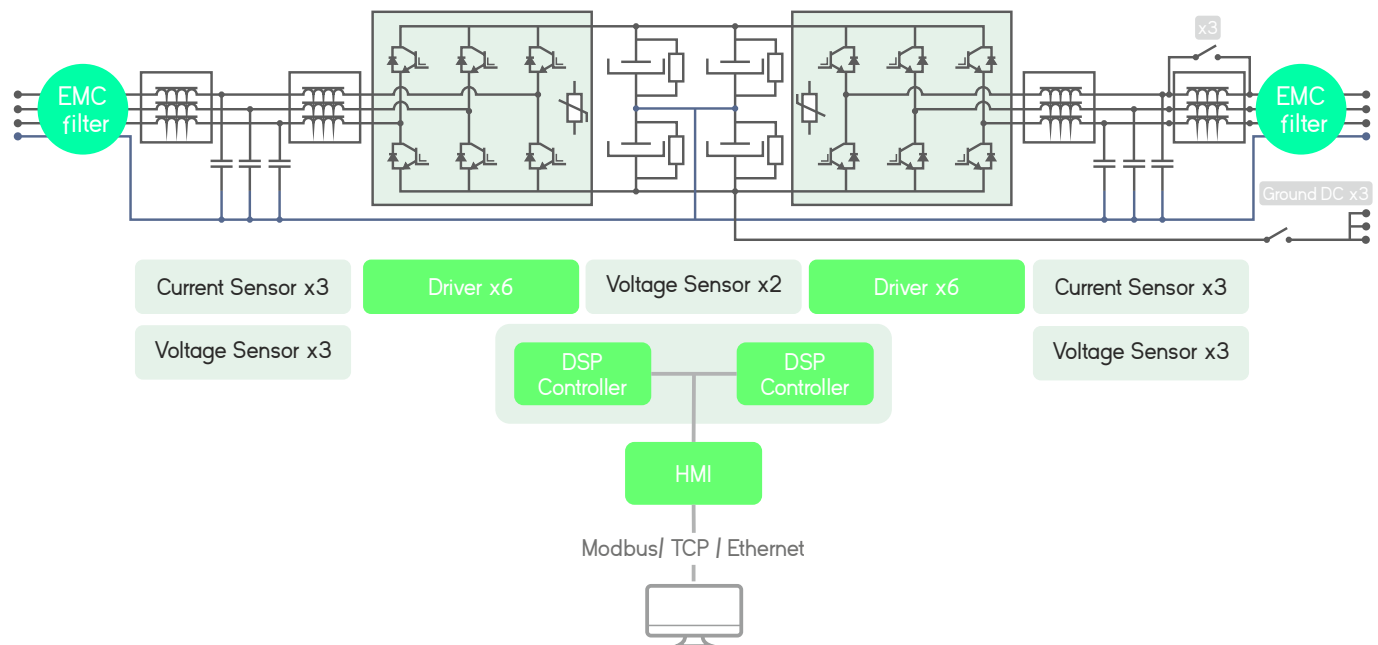

## Local Interface

### Analogue and Digital IO ports

The isolated digital and analogue inputs/outputs permit the connection of the unit to External Controllers and Power Hardware in the Loop systems (option).

### 4.3" Touchscreen

Allows the local parameterization and command of the device, configuration of the communications link, plots the main signals and enables the local datalogging.



### Safety First

The units integrate a local Emergency Stop pushbutton and two signals (input + output) to be connected to the laboratory interlock system. Additionally, the digital outputs can be interfaced to safety tower lights.

# Software Interface in GE+ mode

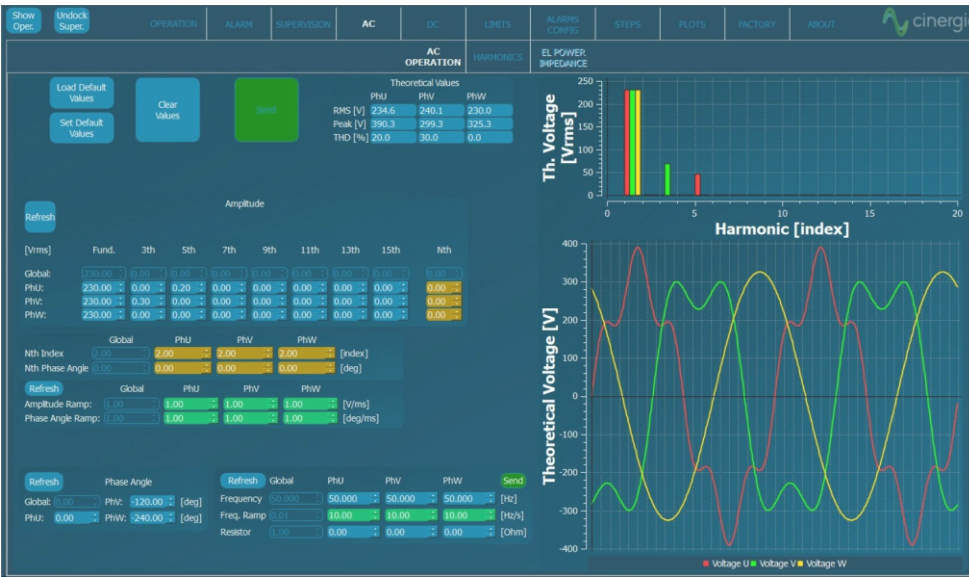

## AC Operation

From this panel, the user can set all AC parameters. Each phase can be independently configured: RMS voltage magnitude, phase delay, harmonics content, free-frequency harmonic and transition ramps. A plot shows the expected real-time waveform, the FFT representation and the numeric data: RMS, peak, CF and THD.

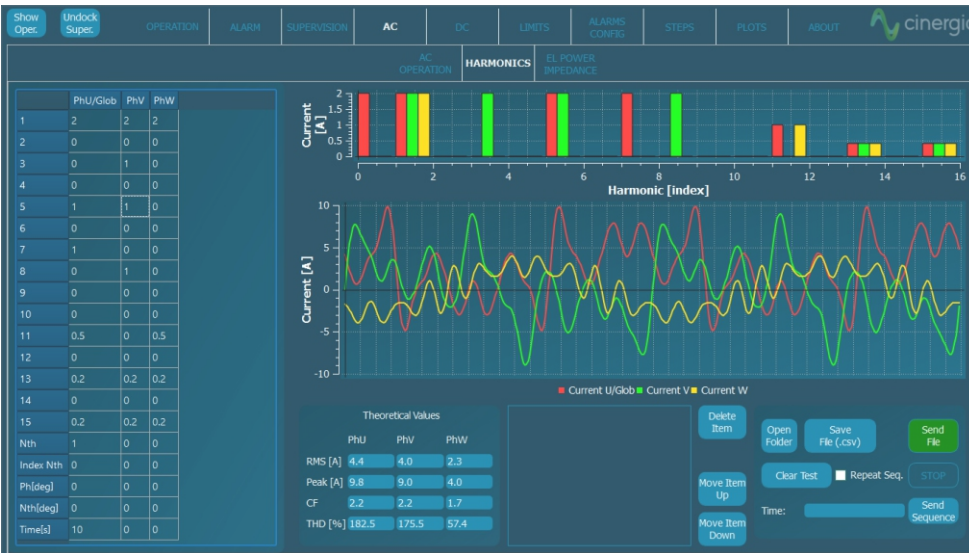

## Harmonics

The device can control simultaneously the magnitude of the first 15 harmonics and one free harmonic per phase. The free one allows the generation of sub-harmonics, inter-harmonics and high frequency harmonics up to the 50th, setting both the magnitude and phase delay.

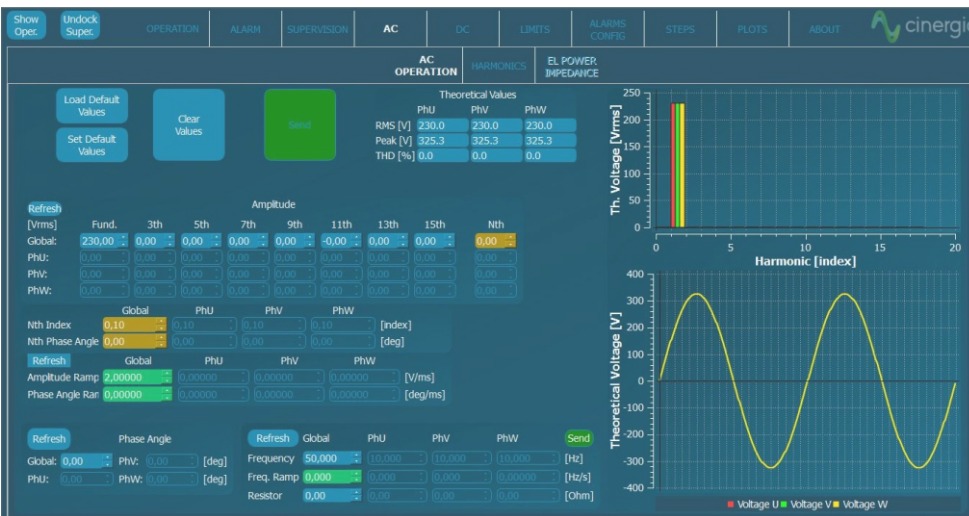

## Parallel Mode

The device can be controlled in parallel mode where all phases are short-circuited internally. This mode it's suitable for single-phase applications.

To increase the total power of the solution, the device can be connected in parallel with multiple devices.

For this connection contact us.



# Advanced AC Software Applications

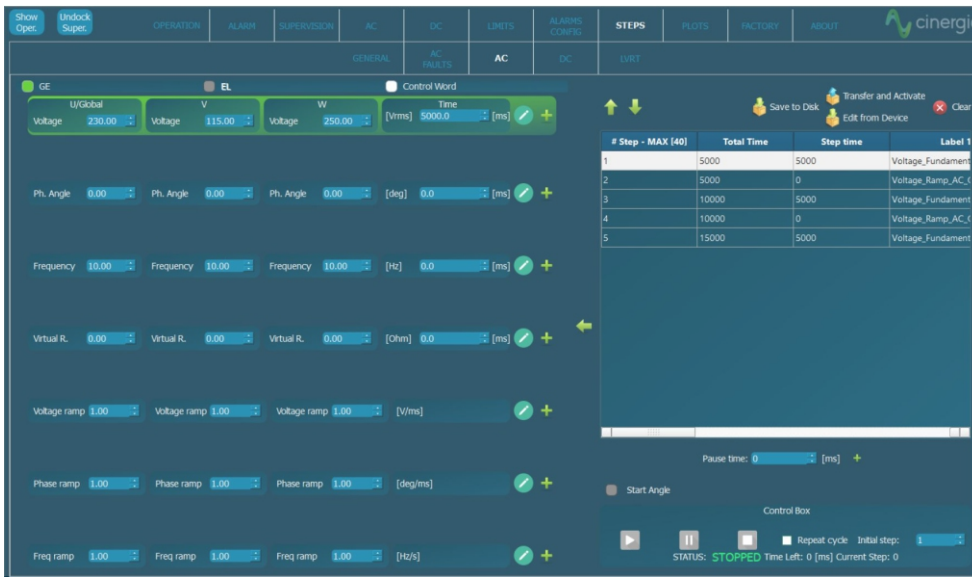

## Steps Mode

One of the most remarkable novelties of the new software is the steps functionality. Step test files are saved and executed by the DSP allowing deterministic timing with a resolution of 66µs. The user gains access to all registers of the device to create complex test sequences which run directly in the converter without the need of an external computer.

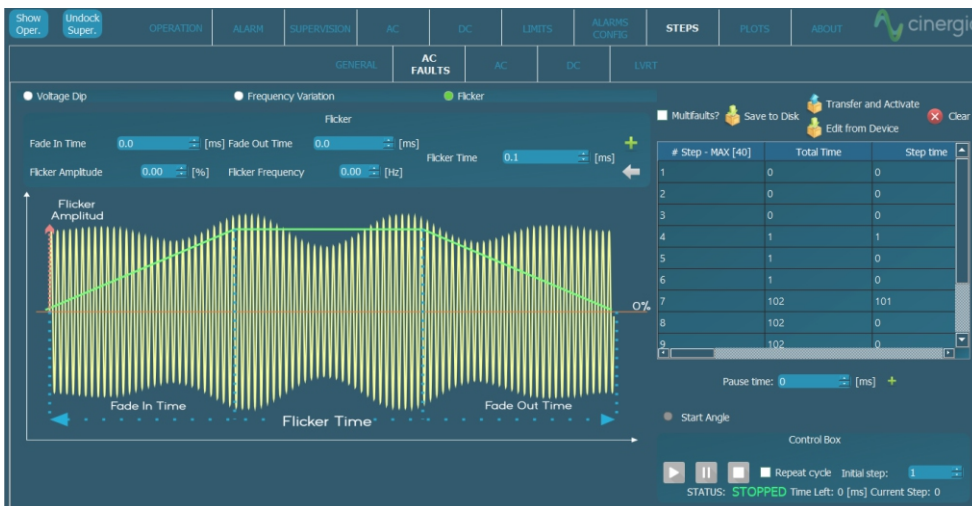

## Disturbance Generation

The steps mode includes predefined easy-to-use test panels. The AC faults panel is a powerful yet intuitive editor which allows generating and configuring voltage dips, frequency variation, flicker and LVRT. Specific profiles can be saved in .csv files, modified, and reused by importing an existing one. The LVRT page have predetermined profiles for different countries.



## IEC Testing (option)

The last version of software includes a library supporting IEC compatible tests. The profiles defined in the standards are preloaded in the software for a user friendly execution and edition. Currently the following standards are available:

- IEC61000-4/11
- IEC61000-4/13
- IEC61000-4/14
- IEC61000-4/28

# Software Interface in DC

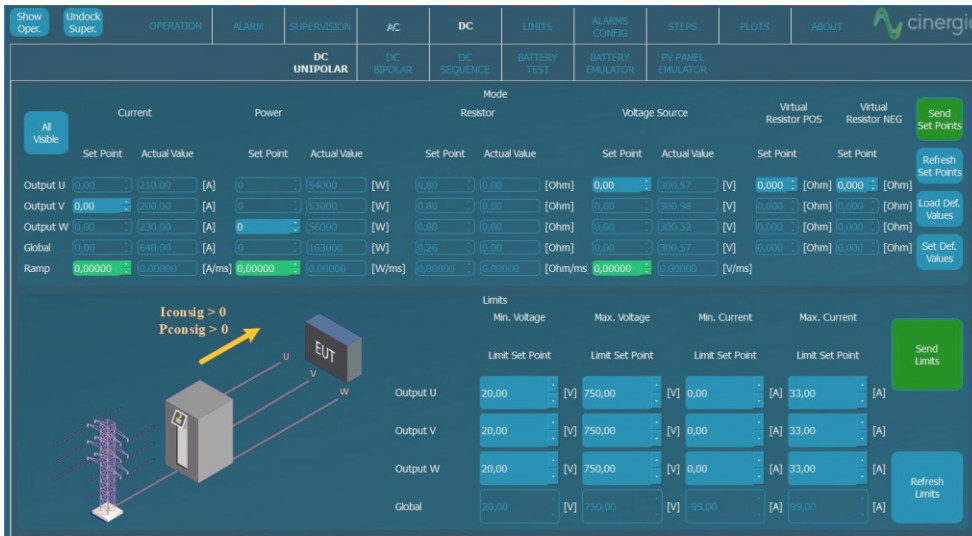

## DC Operation

This panel allows the user to access all DC setpoints and limits. Thanks to the unique Multichannel feature, each phase can have a different Operation Mode: voltage, current, power, resistance and advanced DC applications. Transition ramps, voltage and current limits can be modified. The limits for sink and source operation are different for safer testing, specially in battery applications.

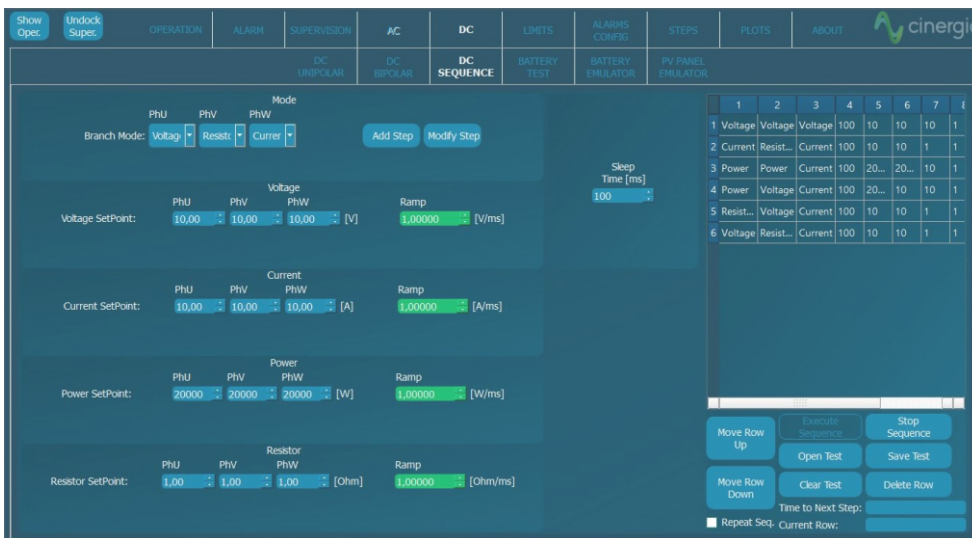

## Sequence

The User Interface Software integrates a Sequence Editor to create automatic test sequences, save them for future use and import them in .csv files. A smart datalogger can be activated from the LCD of the unit to record automatically the resulting voltage and current measurements with a time resolution of 400 ms.

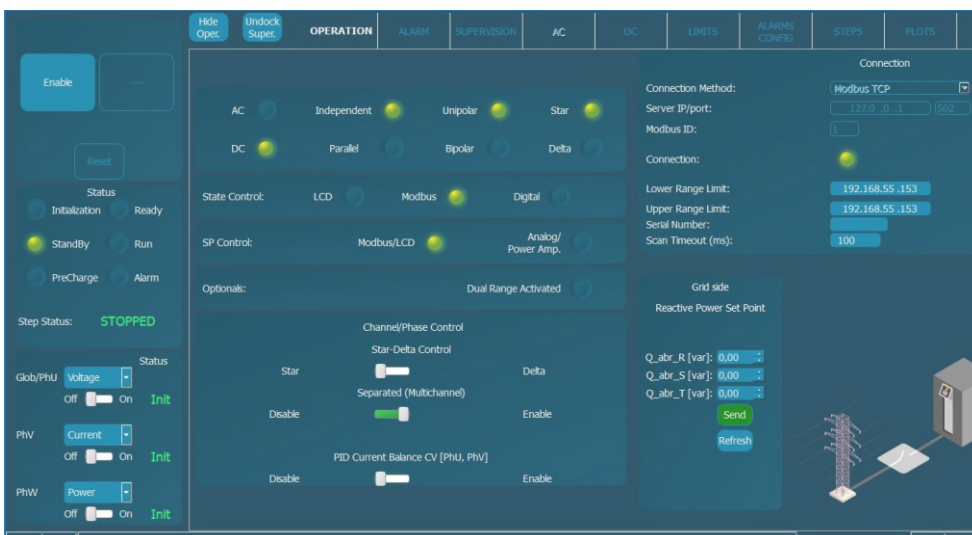

## Multichannel

Enabling the Separated Channel Control converts the device in three functionally independent DC Bidirectional Power Supplies, sharing the common negative rail. Each channel can have a different status (ON, OFF, Warning, Alarm), Operation Mode (see Range and Specifications table), Setpoint, Ramp and Limits.



# Advanced DC Applications

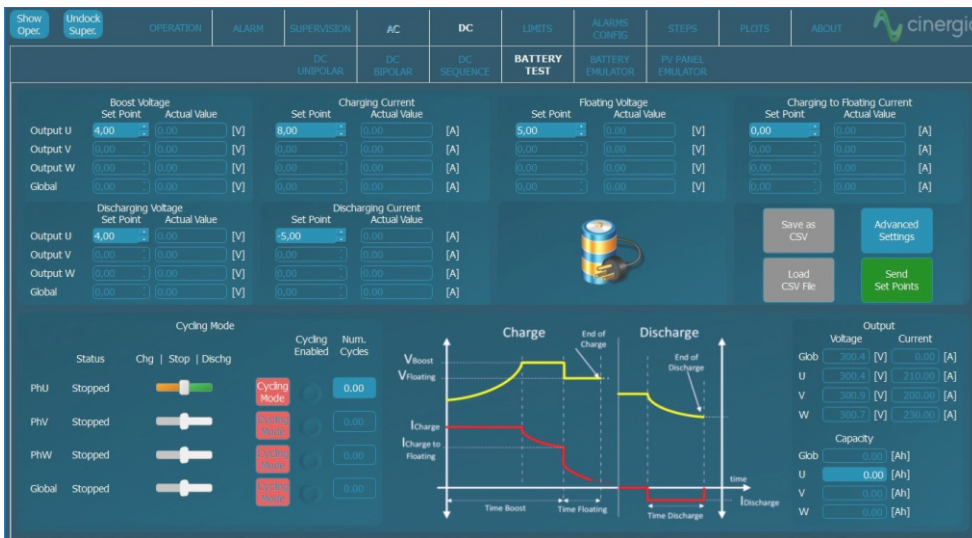

## Battery Pack Testing

This functionality enables the user to precisely control the charge, discharge and cycling of a Battery. Basic parameters include the charge/discharge current, fast charge and floating voltages while Advanced parameters add Energy (Ah) and Time as transition conditions. Profiles for each Battery technology can be saved and imported in .CSV files.

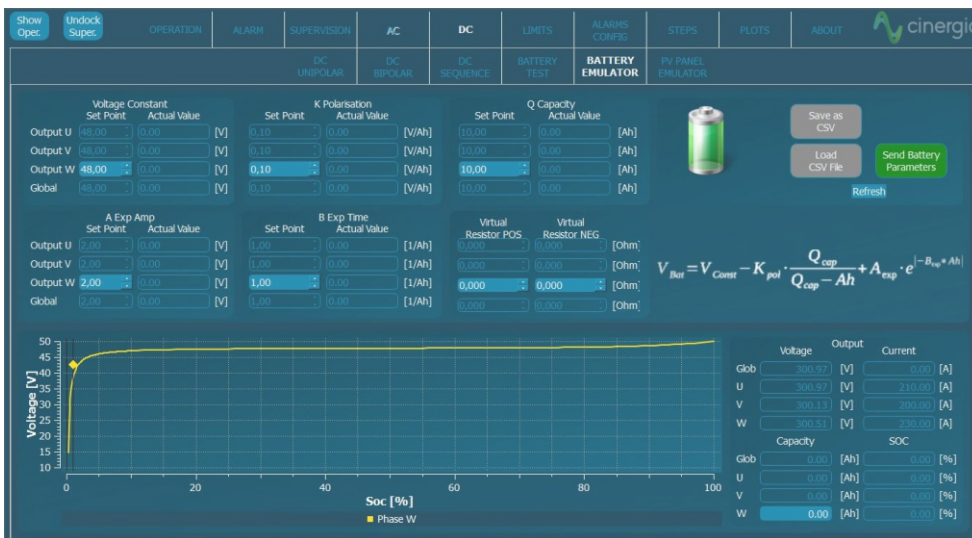

## Battery Emulation

The B2C+ integrates a mathematical model to emulate the voltage behaviour of a real battery pack. The output voltage will change as a function of the SOC and Current. By configuring the provided parameters, the voltage profile can be adjusted to match different technologies: Lilon, NiMH, NiCd, Pb, Flux, etc...

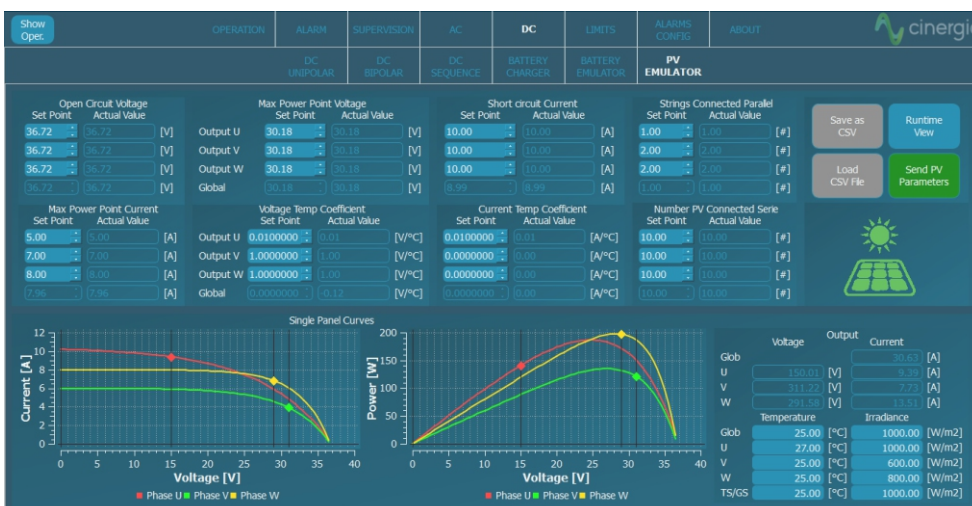

## PV Panel Emulation

The PV Panel model is based on the single-diode equivalent circuit of a PV cell and the series-parallel connection of cells to form a panel. A Runtime functionality allows the simulation of a complete day by launching different irradiance and temperature setpoints from a .csv file, enabling the user burn-in and functional tests of PV Inverters.

# GE+ vAC/DC Full Range & Specifications

---

## Input side (GRID side)

**AC Voltage**  
Rated:  $3 \times 400V_{rms}$  + Neutral + Earth  
Range: +15% / -20%

**Rated AC Current**  
Depends on model (see Wiring Manual)

**Frequency**  
48-62Hz

**Current Harmonic Distortion**  
THDi < 3% at rated power

**Current Power factor**  
PF > 0.98 at rated power

**Efficiency**  
 $\geq 89\%$  (7.5 & 10),  $\geq 91\%$  (15 to 30),  $\geq 92\%$  (40 to 200)

---

## Output side in DC (EUT side)

**Terminals**  
Number: 6 (3 positive + 3 negative)

**Configuration of Channels**  
Unipolar Independent: 2Q, independent setpoints per channel  
Unipolar Parallel: 2Q, one global setpoint for all channels  
Multichannel: 2Q, independent start/stop, operation mode and setpoints per channel (note: multichannel is an option for  $\geq 80kVA$ )  
Bipolar (4Q two independent setpoints)

**Voltage Mode (CV)**  
Range: 2Q:  $20^{(1)}$  to 750V (800V with High Voltage option)  
4Q: 0 to +350V / 0 to -350 (+ rail / 0 / - rail, Bipolar configuration)  
Setpoint Resolution: 10mV  
Effective Resolution<sup>(2)</sup>: < 0.05% of FS<sup>(3)</sup>  
Setpoint Accuracy<sup>(4)</sup>:  $\pm 0.1\%$  of FS<sup>(3)</sup>  
Transient Time<sup>(5)</sup>: < 1ms (10% to 90% at a step to Vrated)  
Ripple<sup>(7)</sup> (peak-peak): < 0.55% of FS<sup>(3)</sup>

**Current Mode (CC)**  
Range: from 0 to  $\pm 110\%$  of Irated (see models table)  
Setpoint Resolution: 10mA  
Effective Resolution<sup>(2)</sup>: < 0.05% of FS<sup>(3)</sup> (< 0.1% models 7.5 & 10)  
Setpoint Accuracy<sup>(4)</sup>:  $\pm 0.2\%$  of FS<sup>(3)</sup>  
Transient Time<sup>(5)</sup>: < 1ms (10% to 90% at a step to Irated)  
Ripple<sup>(7)</sup> (peak-peak): < 0.7% of FS<sup>(3)</sup>

**Power Mode (CP)**  
Range: from 0 to  $\pm 200\%$ <sup>(8)</sup> of Prated (see models table)  
Derived current setpoint: Psetpoint / Vmeasured  
Setpoint Resolution: 1W  
Effective Resolution<sup>(2)</sup>: < 0.1% of FS<sup>(3)</sup> (< 0.25% models 7.5 & 10)  
Setpoint Accuracy<sup>(4)</sup>:  $\pm 0.4\%$  of FS<sup>(3)</sup>  
Transient Time<sup>(5)</sup>: < 2.5ms (10% to 90% at a step to Prated)

**Resistance Mode (CR)**  
Range: from 0.1 to 1000 Ohm  
Derived current: Vmeasured / Rsetpoint  
Setpoint Resolution: 0.01 Ohm  
Setpoint Accuracy<sup>(4)</sup>:  $\pm 0.2\%$  of FS<sup>(3)</sup>  
Transient Time<sup>(5)</sup>: < 2ms (10% to 90% at a step to Rrated))

---

## Output side in AC (EUT side)

**Terminals**  
Number: 4 (3 phases + 1 neutral)

**Configuration of Channels**  
Independent: 4Q, independent setpoints per phase  
Parallel: 4Q, global setpoints for all phases  
Multichannel: 4Q, independent start/stop, alarm status and setpoints per phase (note: multichannel is an option for  $\geq 80kVA$ )

---

---

## Output side in GE-AC

### Voltage Mode (CV)

Peak:  $\pm 400\text{V}$  phase-neutral

Range:  $0^{(1)}$  to  $277\text{Vrms}$  phase-neutral ( $295\text{Vrms}$  with HV option)

$0^{(1)}$  to  $480\text{Vrms}$  phase-phase ( $510\text{Vrms}$  with HV option)

THDv:  $< 0.1\%$  rated linear load at  $230\text{Vrms}$ ,  $50/60\text{Hz}$

$< 0.9\%$  rated non linear load  $\text{CF}=3$  at  $230\text{Vrms}$ ,  $50/60\text{Hz}$

Setpoint Resolution:  $10\text{mVrms}$

Effective Resolution<sup>(2)</sup>:  $< 0.05\%$  of FS<sup>(3)</sup>

Setpoint Accuracy<sup>(4)</sup>:  $< \pm 0.1\%$  of FS<sup>(3)</sup>

Transient Time<sup>(5)</sup>:  $< 1.5\text{ms}$  ( $10\%$  to  $90\%$  at a step to  $V_{\text{rated}}$ )

Ripple<sup>(7)</sup> (peak-peak):  $< 0.55\%$  of FS<sup>(3)</sup>

### Harmonics

Range: up to 50th (at  $50/60\text{ Hz}$  fundamental)

15 independent harmonics per phase:

14 fixed frequency multiple of  $f_0$ : 2,3,4,5,6,7,8,9,10,11,12,13,14,15

1 free programmable frequency from 0.1 to 50 times  $f_0$

Harmonics content:  $V \cdot f < 46000$  (with current derating)

Setpoint Accuracy<sup>(4)</sup>: same as voltage accuracy

Small Signal Bandwidth: up to  $5000\text{Hz}^{(9)}$

Transient Time<sup>(5)</sup>:  $< 2\text{ms}$  ( $10\%$  to  $90\%$  at a step change)

### Frequency

Fundamental Frequency Range:  $10$  to  $100\text{Hz}$  (up to  $400\text{Hz}$  option)

Small Signal Bandwidth: up to  $5000\text{Hz}^{(9)}$

Resolution:  $1\text{mHz}$

### Phase Angle

Range:  $0$  to  $360^\circ$

Resolution:  $0.01^\circ$

---

## Operation Modes

### DC

Programmable Voltage (CV)

Programmable Current (CC)

Programmable Power (CP)

Programmable Resistance (CR)

Power Amplifier (HiL)

Steps

Optional Battery Testing (BTest) (charge/discharge/cycling)

Optional Battery Emulation (BEmu)

Optional PV Panel Emulation (PVEmu)

### AC

Programmable Voltage (CV)

Power Amplifier (HiL)

Steps

Optional IEC 61000

---

## Overload/ Overcurrent

Admissible DC overcurrent is:  $110\%$  of rated value during 1 minute

Admissible AC overcurrent:  $125\%$  of rated value during 10 minutes,

$150\%$  during 1 minute,  $200\%$  during 2 seconds

Admissible overloads:  $125\%$  of rated value during 10 minutes,

$150\%$  during 1 minute,  $200\%$  during 2 seconds

---

## User Interface

Local Control (4.3" Touchscreen panel)

Isolated Digital port: 6 inputs, 4 outputs

Isolated Analogue port: 6 inputs (rms setpoints or power amplifier)

6 outputs (rms readback or real-time readback)

Interlock port: 1 NC Input, 1 NO Output

Emergency Stop pushbutton

### Remote Control Port

LAN Ethernet with Open Modbus-TCP protocol

RS485 (option), CAN and RS232 (using external gateway)

### Software

Graphical User Interface for Windows 7/10

LabView drivers and open Labview interface example

---



**Protections**    Overvoltage (peak, rms), Overcurrent (peak, rms), Overload  
 Shortcircuit, Emergency Stop, Watchdog, Heart Beat, Output  
 Contactor, Wrong Configuration  
 Alarms and Limits are user configurable and can be saved in a  
 password protected EEPROM

**Measurements**<sup>(6)</sup> Grid Voltage (rms), Current (rms), Power (P,Q) and Frequency  
 Output Voltage (rms, avg), Current (rms, avg), Power (P,Q) and  
 Frequency  
 Heatsink Temperatures (x2) and DC Link Voltage  
 Datalogging available through FTP connection

**Ambient**    Operating temperature<sup>(8)</sup>: 5-40°C  
 Relative Humidity: up to 95%, non-condensing  
 Cooling: Forced air  
 Acoustic noise at 1m: < 52dB(A) (7.5 to 60), < 65dB(A) (80 to 120), < 70dB(A) (160 and 200)

**Standards**    CE Marking  
 Operation and Safety: EN-50178, EN-62040-1  
 EMC: EN-62040-2  
 RoHS

All specifications are subject to change without notice.

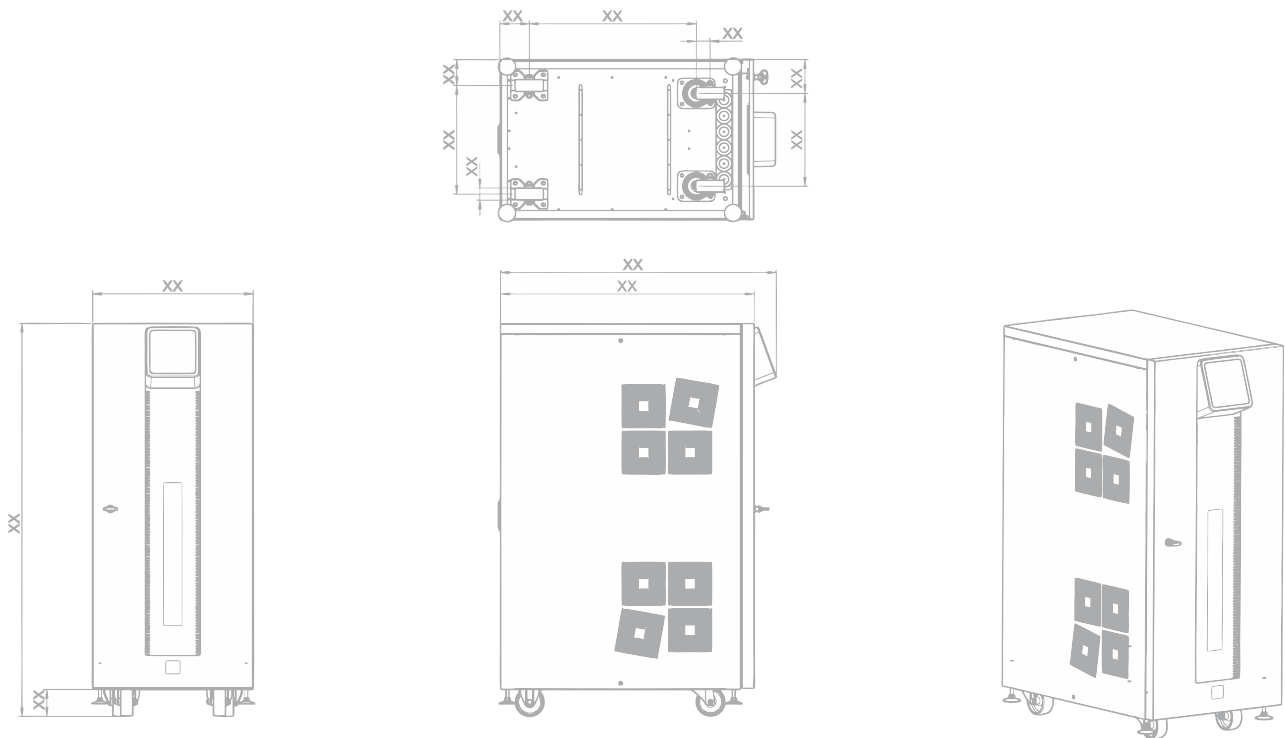

All specifications are subject to change without notice.

(1) Minimum voltage setpoint is 0V in DC. The recommended minimum setpoint for long-term use is 20Vrms in AC and 20V in DC.

(2) Effective resolution measured with a 400ms window

(3) FS Range of voltage is 800V (with High Voltage option)

FS Range of current is 2| 110% to I rated (see models table)

FS Range of power is 2| 200% to Prated (see models table)

(4) Accuracies are valid for settings above 10% of FS

(5) Measured with the rated resistive load and high-dynamics controllers configuration

(6) Accuracy of measurements is ±0.1% of FS for rms voltage, ±0.2% of FS for rms current, ±0.4% of FS for active power (valid only above 10% of FS)

(7) Consult us for lower voltage/current ripple requirements

(8) Rated power figures are given at 20°C

(9) The maximum output voltage depends on frequency following  $V_f < 46000$

# Models

## GE+ vAC/DC Full

Reference	AC Power Rated <sup>(9)</sup>	DC Power Rated <sup>(9)</sup>	AC Current Rated <sup>(9)</sup> RMS Per phase / Parallel	DC Current Rated <sup>(9)</sup> RMS Per phase / Parallel	Weight (kg)	Dimensions DxWxH (mm)
GE+7.5 vAC/DC	7.5kW	7.5kW	11A / 33A	±10A / ±30A	155 kg	770x450x1100 mm
GE+10 vAC/DC	10kW	10kW	15A / 45A	±15A / ±45A	155 kg	770x450x1100 mm
GE+15 vAC/DC	15kW	15kW	22A / 66A	±20A / ±60A	155 kg	770x450x1100 mm
GE+20 vAC/DC	20kW	20kW	29A / 87A	±25A / ±75A	155 kg	770x450x1100 mm
GE+30 vAC/DC	27kW	27kW	40A / 120A	±30A / ±90A	155 kg	770x450x1100 mm
GE+40 vAC/DC	40kW	40kW	58A / 174A	±40A / ±120A	190kg	770x450x1100 mm
GE+50 vAC/DC	50kW	50kW	73A / 219A	±50A / ±150A	190kg	770x450x1100 mm
GE+60 vAC/DC	54kW	54kW	80A / 240A	±57A / ±171A	190kg	770x450x1100 mm
GE+80 vAC/DC	80kW	80kW	116A / 348A	±105A / ±315A	270kg	880x590x1320 mm
GE+100 vAC/DC	100kW	100kW	145A / 435A	±130A / ±390A	295kg	880x590x1320 mm
GE+120 vAC/DC	108kW	108kW	157A / 471A	±130A / ±390A	295kg	880x590x1320 mm
GE+160 vAC/DC	145kW	145kW	211A / 633A	±155A / ±465A	545kg	850x900x2000 mm
GE+200 vAC/DC	160kW	160kW	232A / 696A	±185A / ±555A	555kg	850x900x2000 mm

All specifications are subject to change without notice.

## Galvanic Isolation (optional)

	Circuit Breaker Recommended	Weight (kg)	Dimensions DxWxH (mm)
IT 7.5i	Type C - 25A	145 kg	Inside the cabinet
IT 10i	Type C - 25A	145 kg	Inside the cabinet
IT 15i	Type C - 32A	145 kg	Inside the cabinet
IT 20i	Type C - 40A	145 kg	Inside the cabinet
IT 30i	Type C - 50A	195 kg	Inside the cabinet
IT 30e	Type D - 80A	174 kg	595x415x708 mm
IT 40e	Type D - 100A	217 kg	789x490x865 mm
IT 50e	Type D - 125A	280 kg	789x490x865 mm
IT 60e	Type D - 160A	381 kg	789x490x865 mm
IT 80e	Type D - 200A	435 kg	964x684x1252 mm
IT 100e	Type D - 250A	458 kg	964x684x1252 mm
IT 120e	Type D - 315A	514 kg	964x684x1252 mm
IT 160e	Type D - 400A	612 kg	964x684x1252 mm
IT 200e	Type D - 500A	753 kg	1192x744x1430 mm

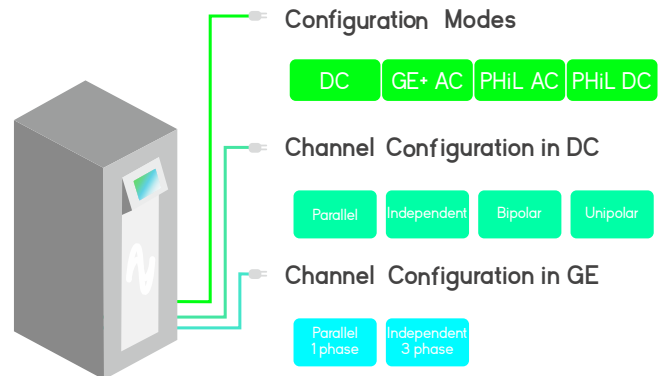

## Options

Choose your options

- Galvanic Isolation
- Multichannel mode: allows different operation mode, start/stop/reset per channel (included in all models from 7.5 to 60, both included)
- 30kHz Switching Frequency: only available for models 15 (derated to 7.5kW), 20 (derated to 7.5kW) and 30 (derated to 10kW)
- Isolation monitor (advised for IT systems)
- Low voltage ripple capacitance
- Anti-islanding monitor (only advised in net injection to the grid and following local regulations)
- High Voltage (HV): voltage up to 295Vrms phase-neutral in AC up to 800V in DC.
- RS485
- Battery Emulation
- Battery Test
- PV Panel Emulation
- Predefined Tests: IEC 61000-4-11, 4-13, 4-14, 4-28,... (consult us for specific Test)

## CINERGIA, Regenerative Power Electronics Solutions

- Grid Emulators AC, DC, AC/DC
- Electronic Loads, AC, DC, AC/DC, HF (360-900Hz)
- Didireccional DC, Battery Emulators, PV Panel Emulators

Pintor Roig i Soler, 10  
08916, Badalona, BARCELONA  
www.cinergia.coop  
cinergia@cinergia.coop