

Regenerative AC Grid Emulator

GE+ vAC is a 4Q programmable AC Voltage Source designed to create both stable and distorted AC grids, adding now a predefined IEC testing software. This cost-competitive solution is specially suitable to perform AC testing in the fields of: Renewable Energy Sources, Smartgrids, EV and EVSE and, in general, grid connected devices.

Key features

Bidirectional and Regenerative
Clean grid current: THDi < 3% and PF > 0.98

13 models from 7.5kW to 160kW
Parallelization of units to increase the power

Generation of Worldwide electrical grids:
3-phase/ 1-phase/ split phase/ Multichannel

Independent phase configuration of:
voltage rms, phase angle, frequency and harmonics

Generation of disturbances:
harmonics, interharmonics, subharmonics, voltage dips
frequency variaton, flicker

Disturbance Generation Editor compatible with IEC,
LVRT, SEMI-F47, CBEMA test standards

Intuitive User Interface
Modbus/Ethernet Open protocol, Labview drivers



Highlights



Efficiency and
Flexibility

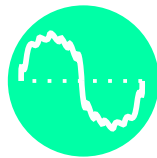

Harmonics
Generation

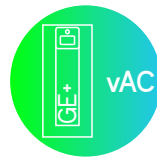

AC only



Smooth
Integration



High-Resolution
and Dynamics

Applications

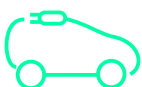

Electrical Vehicles
and EVSE



PV Inverter Testing

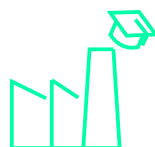

Applications for
Industry and Education

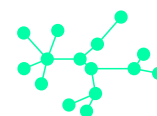

Smartgrids
and ESS



IEC Testing

Bidirectional and Regenerative Hardware

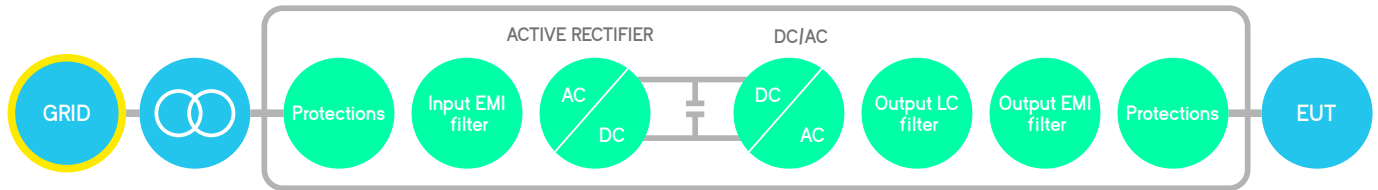

The hardware platform is based on a Back-to-Back power conversion topology, formed by two IGBT-based power stages. The grid side stage is an Active Rectifier which produces clean sinusoidal currents with very low harmonic distortion and power factor close to one.

The EUT side stage can be configured for AC voltage source or AC current source or DC output. In AC, voltage/current are controlled by using state of the art digital Proportional-Resonant controllers. In DC, the three independent buck-boost bidirectional legs enable the separated control of three different DC voltages or currents.

Block diagram

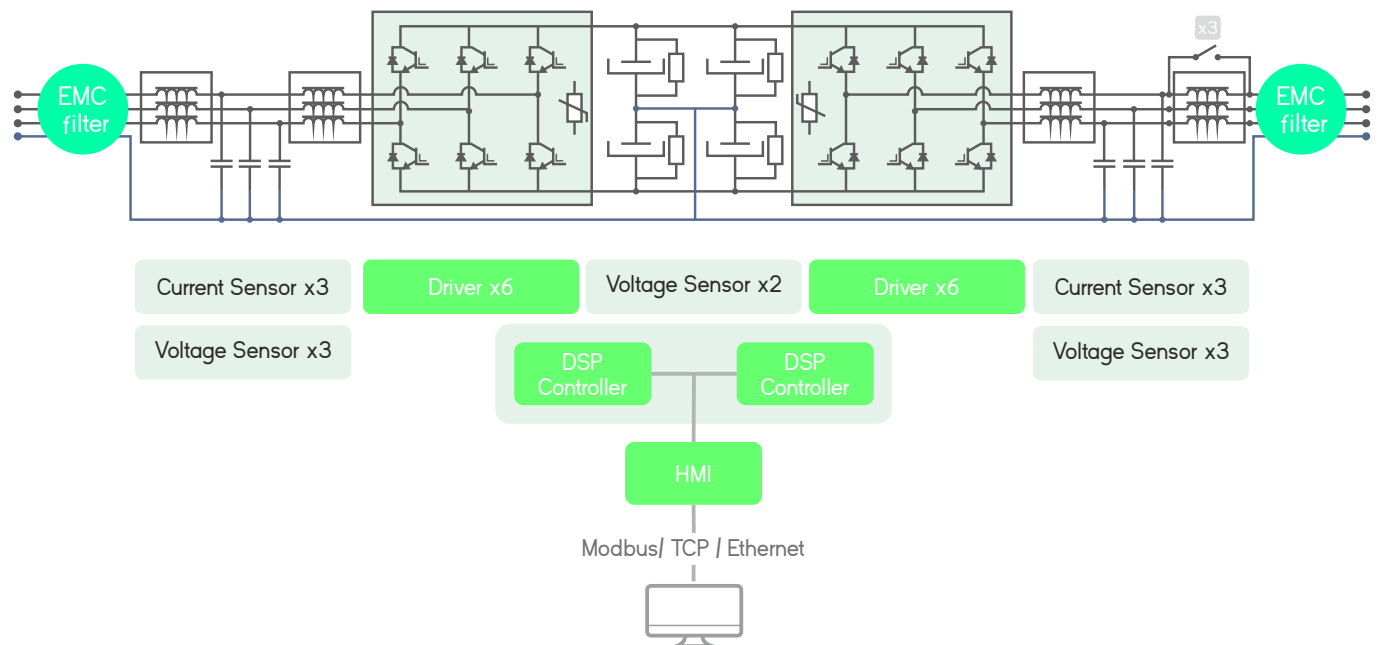

Local Interface

Analogue and Digital IO ports

The isolated digital and analogue inputs/outputs permit the connection of the unit to External Controllers and Power Hardware in the Loop systems (option).

4.3" Touchscreen

Allows the local parameterization and command of the device, configuration of the communications link, plots the main signals and enables the local datalogging.



Safety First

The units integrate a local Emergency Stop pushbutton and two signals (input + output) to be connected to the laboratory interlock system. Additionally, the digital outputs can be interfaced to safety tower lights.

Software Interface in GE+ mode

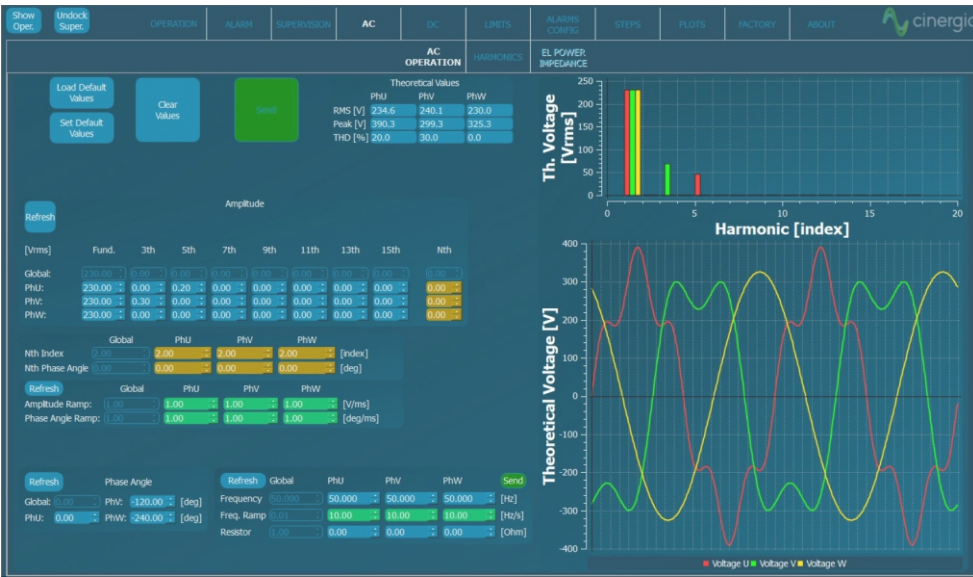

AC Operation

From this panel, the user can set all AC parameters. Each phase can be independently configured: RMS voltage magnitude, phase delay, harmonics content, free-frequency harmonic and transition ramps. A plot shows the expected real-time waveform, the FFT representation and the numeric data: RMS, peak, CF and THD.

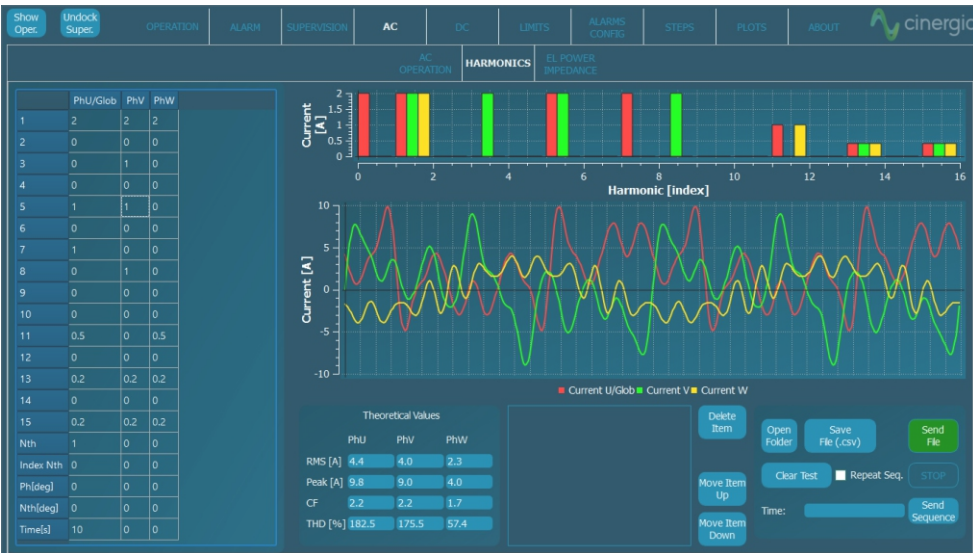

Harmonics

The device can control simultaneously the magnitude of the first 15 harmonics and one free harmonic per phase. The free one allows the generation of sub-harmonics, inter-harmonics and high frequency harmonics up to the 50th, setting both the magnitude and phase delay.

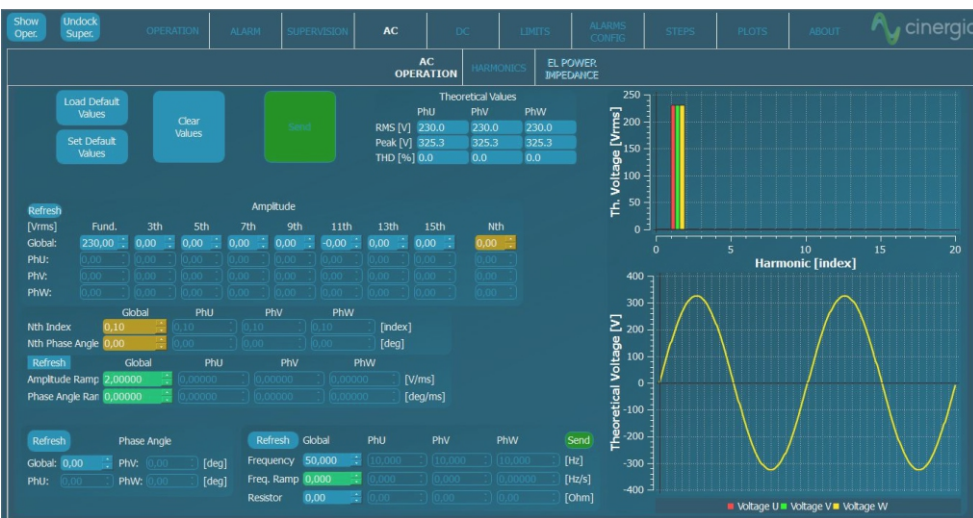

Parallel Mode

The device can be controlled in parallel mode where all phases are short-circuited internally. This mode it's suitable for single-phase applications.

To increase the total power of the solution, the device can be connected in parallel with multiple devices.

For this connection contact us.

Advanced AC Software Applications

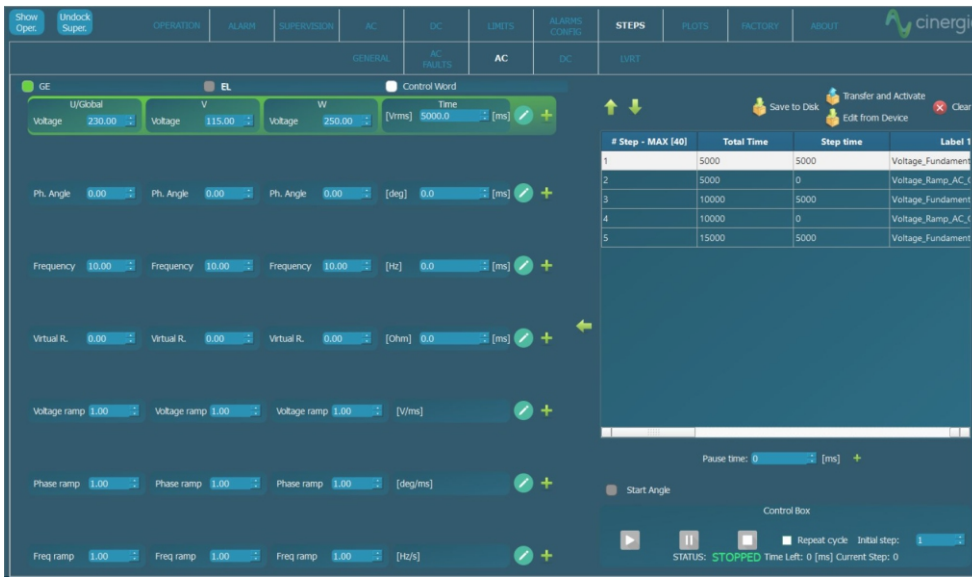

Steps Mode

One of the most remarkable novelties of the new software is the steps functionality. Step test files are saved and executed by the DSP allowing deterministic timing with a resolution of 66µs. The user gains access to all registers of the device to create complex test sequences which run directly in the converter without the need of an external computer.



Disturbance Generation

The steps mode includes predefined easy-to-use test panels. The AC faults panel is a powerful yet intuitive editor which allows generating and configuring voltage dips, frequency variation, flicker and LVRT. Specific profiles can be saved in .csv files, modified, and reused by importing an existing one. The LVRT page have predetermined profiles for different countries.



IEC Testing (option)

The last version of software includes a library supporting IEC compatible tests. The profiles defined in the standards are preloaded in the software for a user friendly execution and edition. Currently the following standards are available:

- IEC61000-4/11
- IEC61000-4/13
- IEC61000-4/14
- IEC61000-4/28

GE+ vAC Range & Specifications

Input side (GRID side)

AC Voltage
Rated: 3x400Vrms + Neutral + Earth
Range: +15% / -20%

Rated AC Current
Depends on model (see Wiring Manual)

Frequency
48-62Hz

Current Harmonic Distortion
THDi < 3% at rated power

Current Power factor
PF > 0.98 at rated power

Efficiency
≥ 89% (7.5 & 10), ≥ 91% (15 to 30), ≥ 92% (40 to 200)

Output side in AC (EUT side)

Terminals
Number: 4 (3 phases + 1 neutral)

Configuration of Channels
Independent: 4Q, independent setpoints per phase
Parallel: 4Q, global setpoints for all phases
Multichannel: 4Q, independent start/stop, alarm status and setpoints per phase (note: multichannel is an option for ≥ 80kVA)

Output side in GE-AC

Voltage Mode (CV)
Peak: ± 400V phase-neutral
Range: 0⁽¹⁾ to 277Vrms phase-neutral (295Vrms with HV option)
0⁽¹⁾ to 480Vrms phase-phase (510Vrms with HV option)
THDv: < 0.1% rated linear load at 230Vrms, 50/60Hz
< 0.9% rated non linear load CF=3 at 230Vrms, 50/60Hz
Setpoint Resolution: 10mVrms
Effective Resolution⁽²⁾: < 0.05% of FS⁽³⁾
Setpoint Accuracy⁽⁴⁾: < ± 0.1% of FS⁽³⁾
Transient Time⁽⁵⁾: < 1.5ms (10% to 90% at a step to Vrated)
Ripple⁽⁷⁾ (peak-peak): < 0.55% of FS⁽³⁾

Harmonics
Range: up to 50th (at 50/60 Hz fundamental)
15 independent harmonics per phase:
14 fixed frequency multiple of f₀: 2,3,4,5,6,7,8,9,10,11,12,13,14,15
1 free programmable frequency from 0.1 to 50 times f₀
Harmonics content: V·f < 46000 (with current derating)
Setpoint Accuracy⁽⁴⁾: same as voltage accuracy
Small Signal Bandwidth: up to 5000Hz⁽⁹⁾
Transient Time⁽⁵⁾: < 2ms (10% to 90% at a step change)

Frequency
Fundamental Frequency Range: 10 to 100Hz (up to 400Hz option)
Small Signal Bandwidth: up to 5000Hz⁽⁹⁾
Resolution: 1mHz

Phase Angle
Range: 0 to 360°
Resolution: 0.01°

Operation Modes

AC
Programmable Voltage (CV)
Steps
Optional IEC 61000

Overload/Overcurrent

Admissible AC overcurrent: 125% of rated value during 10 minutes, 150% during 1 minute, 200% during 2 seconds
Admissible overloads: 125% of rated value during 10 minutes, 150% during 1 minute, 200% during 2 seconds

User Interface

Local Control (4.3" Touchscreen panel)
Isolated Digital port: 6 inputs, 4 outputs
Isolated Analogue port: 6 inputs (rms setpoints or power amplifier)
6 outputs (rms readback or real-time readback)
Interlock port: 1 NC Input, 1 NO Output
Emergency Stop pushbutton
Remote Control Port
LAN Ethernet with Open Modbus-TCP protocol
RS485 (option), CAN and RS232 (using external gateway)
Software
Graphical User Interface for Windows 7/10
LabView drivers and open Labview interface example

Protections

Overvoltage (peak, rms), Overcurrent (peak, rms), Overload
Shortcircuit, Emergency Stop, Watchdog, Heart Beat, Output
Contactor, Wrong Configuration
Alarms and Limits are user configurable and can be saved in a
password protected EEPROM

Mesurements⁽⁶⁾

Grid Voltage (rms), Current (rms), Power (P,Q) and Frequency
Output Voltage (rms, avg), Current (rms, avg), Power (P,Q) and
Frequency
Heatsink Temperatures (x2) and DC Link Voltage
Datalogging available through FTP connection

Ambient

Operating temperature⁽⁸⁾: 5-40°C
Relative Humidity: up to 95%, non-condensing
Cooling: Forced air
Acoustic noise at 1m: < 52dB(A) (7.5 to 60), < 65dB(A) (80 to 120), < 70dB(A) (160 and 200)

Standards

CE Marking
Operation and Safety: EN-50178, EN-62040-1
EMC: EN-62040-2
RoHS

All specifications are subject to change without notice.

All specifications are subject to change without notice.

(1) Minimum voltage setpoint is 0V in DC. The recommended minimum setpoint for long-term use is 20Vrms in AC and 20V in DC.

(2) Effective resolution measured with a 400ms window

(3) FS Range of voltage is 800V (with High Voltage option)

FS Range of current is 2| 110% to I rated (see models table)

FS Range of power is 2| 200% to Prated (see models table)

(4) Accuracies are valid for settings above 10% of FS

(5) Measured with the rated resistive load and high-dynamics controllers configuration

(6) Accuracy of measurements is ±0.1% of FS for rms voltage, ±0.2% of FS for rms current,

±0.4% of FS for active power (valid only above 10% of FS)

(7) Consult us for lower voltage/current ripple requirements

(8) Rated power figures are given at 20°C

(9) The maximum output voltage depends on frequency following $V_f < 46000$

Models

GE+ vAC

Reference	AC Power Rated ¹⁹⁾	AC Current Rated ¹⁹⁾ RMS Per phase / Parallel	Weight (kg)	Dimensions DxWxH (mm)
GE+7.5 vAC	7.5kW	11A / 33A	155 kg	770x450x1100 mm
GE+10 vAC	10kW	15A / 45A	155 kg	770x450x1100 mm
GE+15 vAC	15kW	22A / 66A	155 kg	770x450x1100 mm
GE+20 vAC	20kW	29A / 87A	155 kg	770x450x1100 mm
GE+30 vAC	27kW	40A / 120A	155 kg	770x450x1100 mm
GE+40 vAC	40kW	58A / 174A	190kg	770x450x1100 mm
GE+50 vAC	50kW	73A / 219A	190kg	770x450x1100 mm
GE+60 vAC	54kW	80A / 240A	190kg	770x450x1100 mm
GE+80 vAC	80kW	116A / 348A	270kg	880x590x1320 mm
GE+100 vAC	100kW	145A / 435A	295kg	880x590x1320 mm
GE+120 vAC	108kW	157A / 471A	295kg	880x590x1320 mm
GE+160 vAC	145kW	211A / 633A	545kg	850x900x2000 mm
GE+200 vAC	160kW	232A / 696A	555kg	850x900x2000 mm

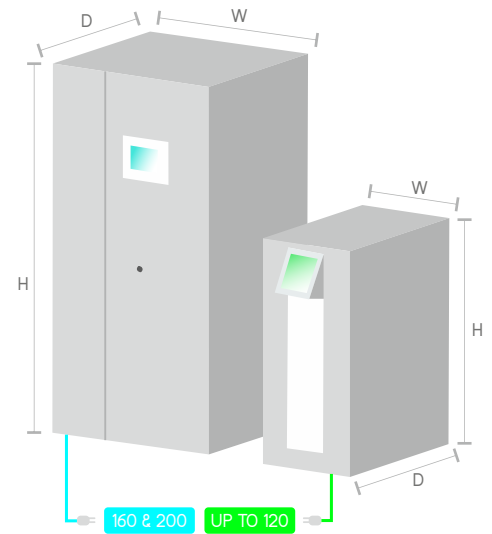

All specifications are subject to change without notice.

Galvanic Isolation (optional)

	Circuit Breaker Recommended	Weight (kg)	Dimensions DxWxH (mm)
IT 7.5i	Type C - 25A	145 kg	Inside the cabinet
IT 10i	Type C - 25A	145 kg	Inside the cabinet
IT 15i	Type C - 32A	145 kg	Inside the cabinet
IT 20i	Type C - 40A	145 kg	Inside the cabinet
IT 30i	Type C - 50A	195 kg	Inside the cabinet
IT 30e	Type D - 80A	174 kg	595x415x708 mm
IT 40e	Type D - 100A	217 kg	789x490x865 mm
IT 50e	Type D - 125A	280 kg	789x490x865 mm
IT 60e	Type D - 160A	381 kg	789x490x865 mm
IT 80e	Type D - 200A	435 kg	964x684x1252 mm
IT 100e	Type D - 250A	458 kg	964x684x1252 mm
IT 120e	Type D - 315A	514 kg	964x684x1252 mm
IT 160e	Type D - 400A	612 kg	964x684x1252 mm
IT 200e	Type D - 500A	753 kg	1192x744x1430 mm

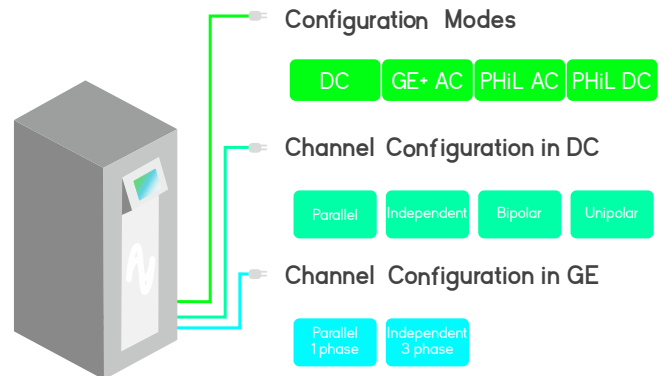

Options

Choose your options

- Galvanic Isolation
- Multichannel mode: allows different operation mode, start/stop/reset per channel (included in all models from 7.5 to 60, both included)
- 30kHz Switching Frequency: only available for models 15 (derated to 7.5kW), 20 (derated to 7.5kW) and 30 (derated to 10kW)
- Isolation monitor (advised for IT systems)
- Low voltage ripple capacitance
- Anti-islanding monitor (only advised in net injection to the grid and following local regulations)
- High Voltage (HV): voltage up to 295Vrms phase-neutral in AC up to 800V in DC.
- RS485
- Predefined Tests: IEC 61000-4-11, 4-13, 4-14, 4-28... (consult us for specific Test)

CINERGIA, Regenerative Power Electronics Solutions

- Grid Emulators AC, DC, AC/DC
- Electronic Loads, AC, DC, AC/DC, HF (360-900Hz)
- Didireccional DC, Battery Emulators, PV Panel Emulators

Pintor Roig i Soler, 10
08916, Badalona, BARCELONA
www.cinergia.coop
cinergia@cinergia.coop